

FEATURES:

- unique modular design and full range of accessories allows to assembly a patch panel as needed
- three adapter slots can be covered by SC, ST, LC or FC-D-flange adapter panels of 4,6 or 8 ports, or with blank panels. The adapter panels are available unloaded or fully loaded (see accessories)
- splice cassette with cable routings available (see accessories)
- position of splice cassette adjustable
- fits all standard 19 inch racks, height / port number: 1U / 4 to 24ports
- smooth sliding tray with self lock function can be opened up to an 155° angle
- material/thickness of body and adapter panels: cold rolled steel/1.6 mm
- material of splice cassette and cable routing: ABS
- TIA/EIA 568-B.3 compliant
- RoHS compliant



APPLICATIONS:

- Telecommunications
- Local Area Network
- FTTH deployments
- CATV
- Provide termination, protection, connection, management of fiber optic cable

Premium Line Systems GmbH reserves the right to change specifications without prior notice.

DRAWING:

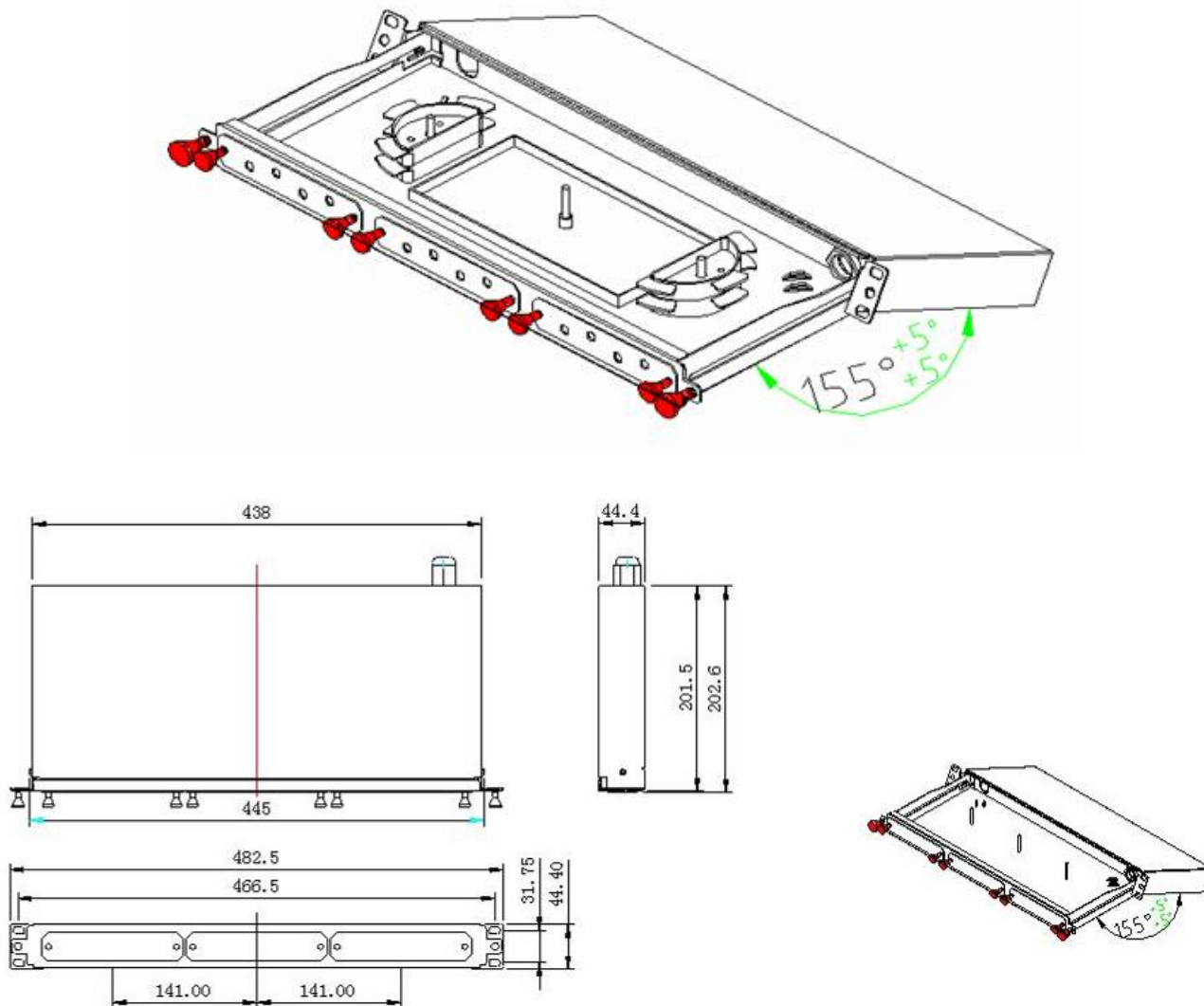

ORDERING INFORMATION:

Part No.	241100002
Description	Premium Line 19" fiber optic patch panel, main body, black
Packing	1pc/box, 5pcs/carton
Carton dimension	55 x 28 x 30 cm, Weight: G.W. 16.7 kg N.W. 14.5 kg

Premium Line Systems GmbH reserves the right to change specifications without prior notice.

ACCESSORIES:

Part No.	Description
243000005	splice cassette for 12-port, grey (including 1 pc of tray, 2 pcs of spool cable routings and 12 pcs of heat shrinking tube)
2423x1042	4port SC adapter panel, simplex, black x=0: unloaded; x=1: MM adapter fully loaded; x=2: SM adapter fully loaded
2424x1042	4port SC adapter panel, duplex, black x=0: unloaded; x=1: MM adapter fully loaded; x=2: SM adapter fully loaded
2423x1062	6port SC adapter panel, simplex, black x=0: unloaded; x=1: MM adapter fully loaded; x=2: SM adapter fully loaded
2423x1082	8port SC , adapter panel, simplex, black x=0: unloaded; x=1: MM adapter fully loaded; x=2: SM adapter fully loaded
2423x2042	4port ST, adapter panel, simplex, black x=0: unloaded; x=1: MM adapter fully loaded; x=2: SM adapter fully loaded
2423x2062	6port ST adapter panel, simplex, black x=0: unloaded; x=1: MM adapter fully loaded; x=2: SM adapter fully loaded
2423x2082	8port ST adapter panel, simplex, black x=0: unloaded; x=1: MM adapter fully loaded; x=2: SM adapter fully loaded
2424x4042	4port LC adapter panel, duplex, black x=0: unloaded; x=1: MM adapter fully loaded; x=2: SM adapter fully loaded
2424x4062	6port LC adapter panel, duplex, black x=0: unloaded; x=1: MM adapter fully loaded; x=2: SM adapter fully loaded
2424x4082	8port LC adapter panel, duplex, black x=0: unloaded; x=1: MM adapter fully loaded; x=2: SM adapter fully loaded
2423x3042	4port FC (D flange type) adapter panel, simplex, black x=0: unloaded; x=1: MM adapter fully loaded; x=2: SM adapter fully loaded
2423x3062	6port FC (D flange type) adapter panel, simplex, black x=0: unloaded; x=1: MM adapter fully loaded; x=2: SM adapter fully loaded
2423x3082	8port FC (D flange type) adapter panel, simplex, black x=0: unloaded; x=1: MM adapter fully loaded; x=2: SM adapter fully loaded
242500002	blank panel, black

ACCESSORIES:

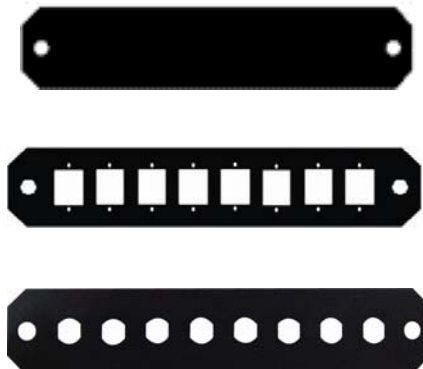

ADAPTER PANEL DRAWINGS:

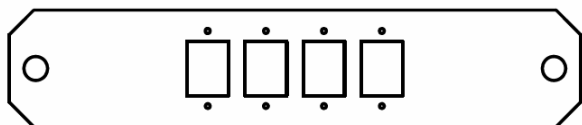

4 port SC Simplex/LC Duplex adapter panel

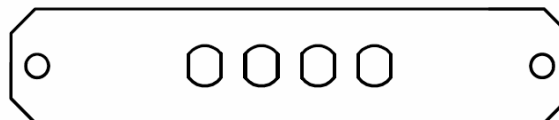

4 port ST/FC Simplex adapter panel

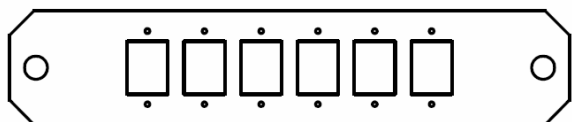

6 port SC Simplex/LC Duplex adapter

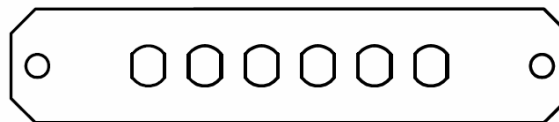

6 port ST/FC Simplex adapter panel

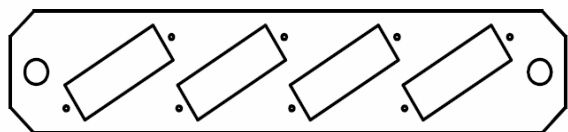

4 port SC Duplex adapter panel

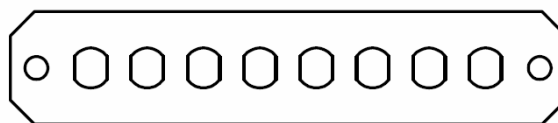

8 port ST/FC Simplex adapter panel



splice cassette for 12 ports, including 1 pc of tray and 2 pcs of cable routing and 12 pcs (60*3mm) of heat shrinking tube

Premium-Line Systems GmbH, Rosenheimer Str.89, D-83064 Raubling, Germany

► TEL: + 49(0)8035 9836 0 ► Fax: + 49(0)8035 9836 22

Premium Line Systems GmbH reserves the right to change specifications without prior notice.